

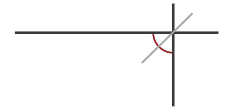

T H E R H I N O D O O R

RHINO ALUMINIUM



C O N T E N T S

Introduction.....	3
Features.....	5
Options & Finishes.....	7
Styles.....	9
Colour & Handle Options.....	13
Keyless Entry.....	15
Winkhaus AV2 Locking System.....	17
Yale 3 Star Cylinder.....	19
Enquiries.....	21

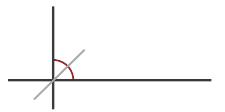



THE ENTRANCE to any property is the focal point of a building's exterior. A Rhino door will add a touch of distinctive elegance to the entry of your home. Our entrance doors bring many benefits including; aesthetics, security, functionality and performance

The Rhino range of front doors are engineered to the highest industry standards, and boast a wide array of design options; from the sleek and subtle, to superior and grand contemporary designs.

ALL of our entrance doors have modern, distinctive aesthetics, and are designed and specified to perfectly compliment the full range of our other architectural window and door products. This range enables us to offer a custom designed product solution for every door and window requirement in your redevelopment or new build project.

FEATURES

- ULTRA SECURE NON BEADED, STRUCTURALLY BONDED PANEL
 - 52MM PANEL DEPTH
- TOUGHENED SAFETY GLASS - 48MM TRIPLE GLAZED
 - ARGON GAS
- STIRLING STAINLESS BAR HANDLES
- WINKHAUS AV2 AUTO LOCKING WITH KEY OPERATION
- YALE ANTI BUMP KEY CYLINDER WITH INTERNAL THUMB TURN OPTION
 - 2 PART SECURITY HINGES & HINGE HORNS
- THERMALLY BROKEN ALUMINIUM PROFILE SYSTEM THROUGHOUT
 - DETAILED & TAILED FINISH OPTIONS

A SUPERIOR ENTRANCE

OPTIONS & FINISHES

We offer a wide range of designs, colours and additional features; such as curved handles, finger point entry, and unique & bespoke colour designs.

FINISHES TO COMPLIMENT ANY THEME

GLASS OPTIONS

All of our glazing is triple glazed as standard, but we offer 2 different glass options to best suit your entrance.

- OUR OBSCURED OPTION AVAILABLE IS A SATIN FINISH ALSO KNOWN AS SAND BLAST, WHICH GIVES 100% PRIVACY, YET ALLOWS PLENTY OF LIGHT TO PASS THROUGH
- OUR FULLY TRANSPARENT PANELS ARE UNCOLOURED AND UNTINTED



The Rhino Door has 2 finish options to choose from. Using precise craftsmanship, these features are unique to Rhino Aluminium, and really do enhance the grand appearance of a property entrance.

- 1 THE DETAILED FINISH
- 2 THE TAILED FINISH

FINISH OPTIONS



ANGOLA
DETAILED

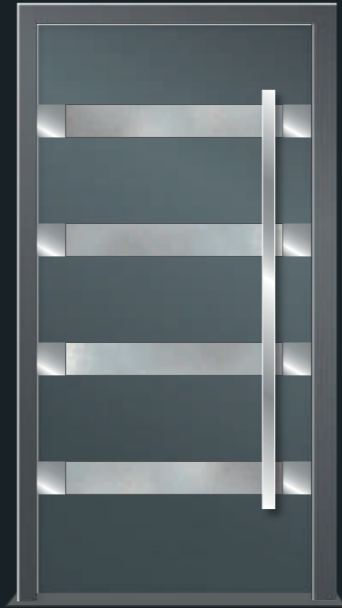

BALI
4 TAILED



JAVA



KULON
DETAILED



SAVANNAH
5 TAILED



MALAWI



MOWSAMBIQUE
TAILED

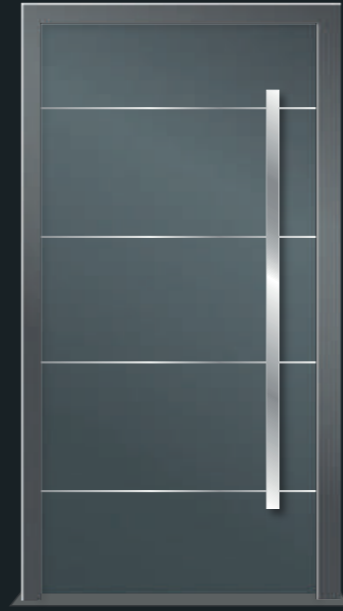

TANZANIA
4 DETAILED



KULON

STYLES

The SAVANNAH is our flagship door. For those entrances that require just that little bit of superiority, this design goes the extra mile.

European design, British manufacturing

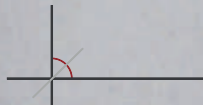

SPECIFICATIONS & TECHNOLOGY

The Rhino Entrance Door is a modern and contemporary take on the average front door. With our unique thermal break design, high levels of thermal & acoustic insulation and a low threshold option to comply with Part M regulations; this will overall improve thermal performance and will satisfy most architectural requirements. Dimension options up to 1200mm in width and 2400mm in height, and a full range of customisable hardware available.



- Slim outer frame
- Flush Finished Sash
- Automatic Multi-Point Locking
- Width option upto 1200mm and height upto 2400mm
- Key operation locking system

- AV2 E Motorised operation
- Low Threshold option
- 9 contemporary Styles and Designs
- Various Textured Finish Colour Options
- ekey Entry available
- Stainless Steel Hardware
- Detail finishes
- Range of Configurations

Performance and accreditation

Uw-Value (Double Glazing)	1.7 W/m ² K
Uw-Value (Triple Glazing)	1.4 W/m ² K
Air Tightness	Class 4 (600 Pa)
Water Tightness	Class 7A (450 Pa)
Wind Load	Class E2400
Security	Kitemarked PAS24

Size Limits

Max Sash Weight	90 Kg
Max Sash Dimension	1200mm (w) 2400mm (h)

System Features

Dual Colour Option	✓
Multi-point Locking	✓
Gazing Options	46mm 52mm

Thermal breaks shown in red.

Threshold Detail

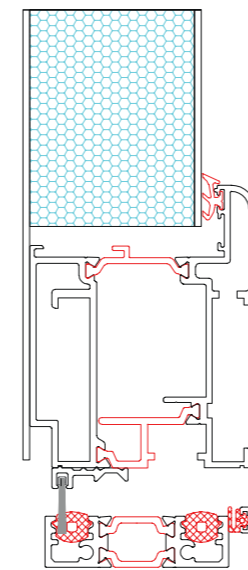

Hinge Detail

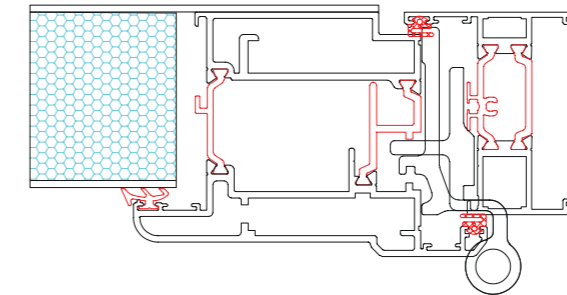

Jamb Detail

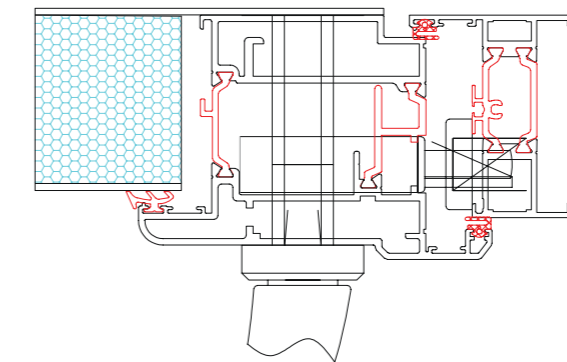

The diagrams shown here illustrate some of the configurations achievable with the Rhino door.

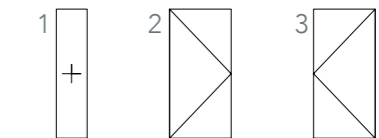
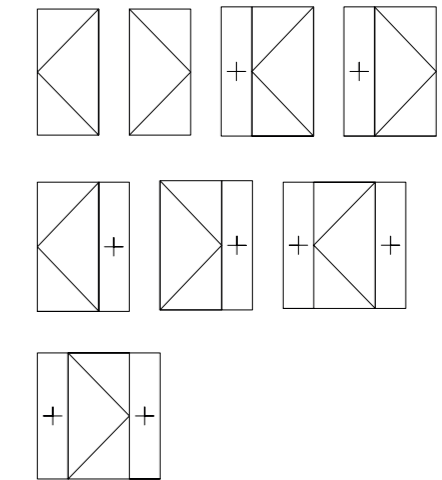

1) Fixed Panel 2) Hinged Right 3) Hinged Left



HIPCA WHITE

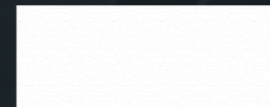

RAL 9910

ANTHRACITE GREY



RAL 7016

JET BLACK

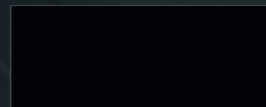

RAL 9005

The Rhino Door has 3 standard colours which are available from stock with no additional colour surcharges.

- THE STANDARD RANGE OF COLOURS CONSIST OF - HIPCA WHITE
- ANTHRACITE GREY
- JET BLACK
- TEXTURED FINISH AS STANDARD

COLOUR OPTIONS

PURE WHITE



RAL 9010

TRAFFIC WHITE



RAL 9016

CREAM

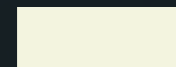

RAL 9001

OYSTER WHITE

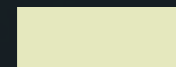

RAL 1013

LIGHT GREY

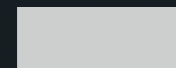

RAL 7035

GREY ALUMINIUM



RAL 9007

DUSTY GREY

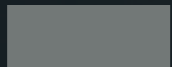

RAL 7037

WHITE ALUMINIUM



RAL 9006

SILK GREY

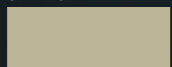

RAL 7044

PEBBLE GREY

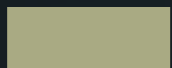

RAL 7032

YELLOW GREY

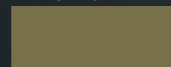

RAL 7034

GREY BEIGE



RAL 1019

LIGHT IVORY

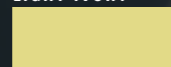

RAL 1015

QUARTZ GREY

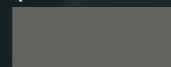

RAL 7039

PALE GREEN



RAL 6021

MOSS GREEN

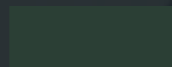

RAL 6005

FIR GREEN

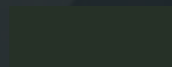

RAL 6009

OLIVE GREEN

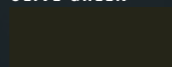

RAL 6003

SEPIA BROWN

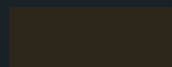

RAL 8014

UMBRA GREY

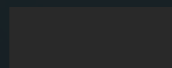

RAL 7022

WINE RED



RAL 3005

PURPLE RED



RAL 3004

GENTIAN BLUE



RAL 5010

GRAPHITE GREY

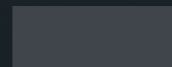

RAL 7024

BLACK GREY

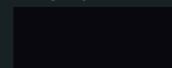

RAL 7021

HANDLE OPTIONS

Rhino Aluminium offer four types of handle, as detailed. These are high quality brushed stainless steel, providing a sublime finish to the doors.

- FLAT BAR HANDLE
- FLAT CURVED BAR HANDLE
- ROUND INLINE BAR HANDLE
- BOW HANDLE

- THE BAR HANDLE LENGTHS ARE AVAILABLE IN 1000MM, 1200MM & 1600MM
- BOW HANDLE LENGTH 585MM

Brushed stainless steel cylinder escutcheons matched to exterior handle and internal lever handles come as standard with any Rhino Door.



KEYLESS ENTRY

State-of-the-art access solutions are a fundamental feature of advanced building concepts, and the first impression counts. The RHINO door can be fitted with optional keyless entry from Europe's premier keyless entry provider ekey.

Made in Austria, all ekey products undergo a rigorous endurance test before they reach the market. The test involves intensive simulations of blazing heat, biting cold, and high humidity, and every finger scanner is subjected to these conditions, along with all of its components, countless times before reaching the customer.

- THE MOST SECURE, MOST CONVENIENT WAY OF ENTERING A HOUSE
- EXTENSIVE PRODUCTION, MANUFACTURING, AND FUNCTIONAL TESTING (ZERO TOLERANCE)
- TESTING FOR ENVIRONMENTAL AND TEMPERATURE RESISTANCE
- VIBRATION AND SHOCK-TESTED
- TESTED FOR PENETRATION OF WATER AND MECHANICAL PARTS
- QUALITY MANAGEMENT SYSTEM IN ACCORDANCE WITH EN ISO 9001:2008
- CAN STORE UP TO 99 FINGERPRINTS OR CODES
- CAN BE USED TO CONTROL FROM 1 TO 3 FUNCTIONS (E.G. DOOR, GATE AND ALARM SYSTEM)
- OPERATE BY USING THE EKEY HOME APP (EKEY FINGER SCANNER INTEGRA BLUETOOTH)
- OPTIONAL CARD ACCESS (RFID)

ekey
YOUR FINGER. YOUR KEY.

INTEGRA



For cavity wall or outlet mounting and integration into doors.

WALLMOUNT



The model to suit any requirement

KEYPAD

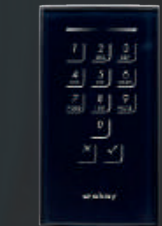

The ekey codepad serves as an alternative to the fingerprint scanner

WINKHAUS AV2 LOCKING SYSTEM

With over 160 years experience in producing locking systems for the world market, Winkhaus is a market leader producing innovative security solutions to meet the challenges of tomorrows rapidly changing security and ease of use requirements.

Superbly engineered and manufactured in Germany the AV2+ Locking system is approved by the Police 'Secured by Design' security initiative. This important independent endorsement is an essential requirement of the Association of British insurers.

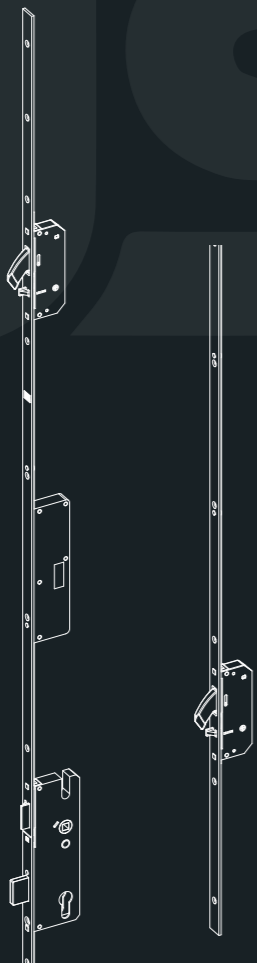

By eliminating the need to lift the handle to engage the lock, the AV2 is ideal for the elderly. The AV2 has uniquely been awarded The Owl Mark™ approval issued by the University of Birmingham Centre for Gerontology which independently assesses products for their suitability of use with the aged.

The AV2 is never "just locked on the latch". When closing the door, two solid anti-pushback hooks automatically operate to achieve instant security.

Tested to PAS24 the AV2 hook shape provides low operating forces and helps doors achieve a higher level of weather performance.

Winkhaus locks have a protective surface coating in excess of EN 1670 : 2007 Grade 4 which is designated as 'Very high corrosion resistance'.

When the door is closed, high security nickel plated steel hooks fully penetrate the heavy duty steel keeps and help prevent forcing apart of the door and frame. AV2 is Police Secured By Design, PAS 24, SKG, and VdS accredited.

The high performance gearbox is tested to 100,000 cycles and offers the lowest possible operating forces and helps prevent handle 'droop'.



BESPOKE DESIGNS PRODUCED IN OUR OWN UK FACTORIES



YALE 3 STAR CYLINDER

The Yale Platinum 3 Star Euro Profile cylinder is a TS007 3 star Kitemarked Anti-Snap security product to provide maximum security against known cylinder attack methods.

The Platinum 3 Star cylinder is independently tested by BSI to be awarded the British Kitemarked TS007:2014 3 star accreditation.

Specification

- TS007 2014 3 STAR APPROVED
- KM559658
- BSEN1303:2005 APPROVED
- ANTI-SNAP, SACRIFICIAL FRONT SECTION
- ANTI-PICK, ANTI-BUMP, ANTI-SCREW, ANTI-PULL AND ANTI-DRILL EURO RETROFIT CYLINDER



ANTI-SNAP

A small section of the cylinder is sacrificed under attack, leaving the remainder of the cylinder intact, and your door safely locked

ANTI-BUMP

Specialised side pins provide bump resistance

ANTI-PICK

Unique multi shear-line technology designed to resist lock picking and bumping

HORIZONTAL KEYWAY

With reversible flat key for easy key entry

CERTIFIED

Approved to TS007:2014 3 star - the highest certifiable level.

INNER STRENGTH

The dedicated central bridge delivers unparalleled inner strength to the cylinder providing protection even if the cylinder is attacked from the outside

ANTI-DRILL

Hardened steel protection incorporated within the cylinder provides heavy resistance against drill attacks

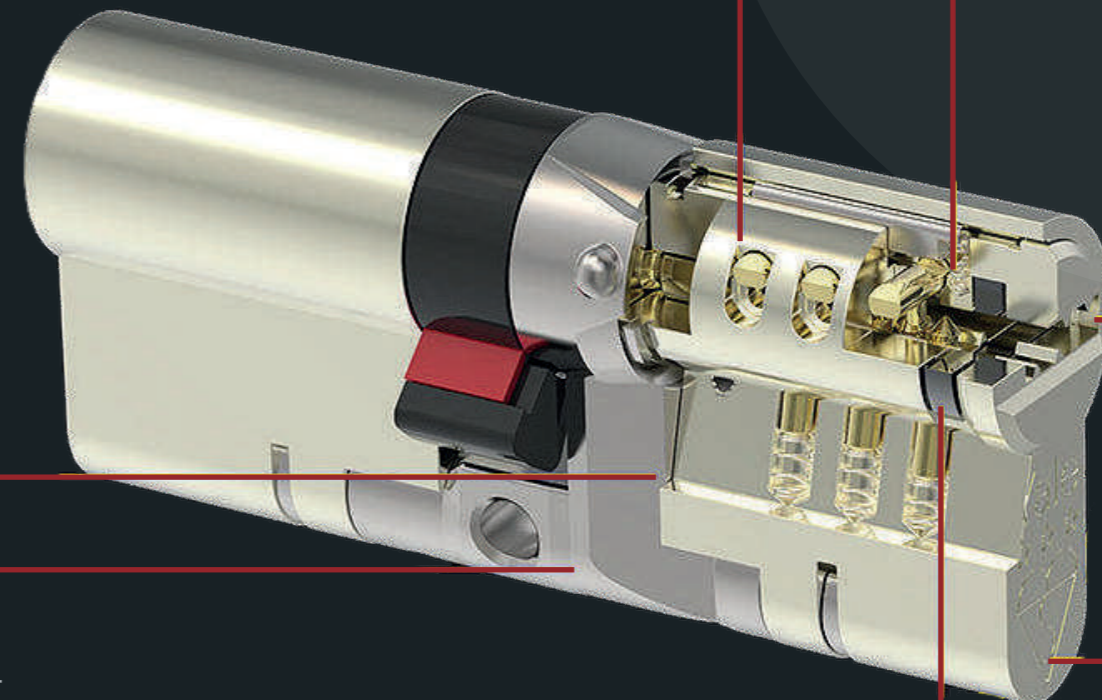

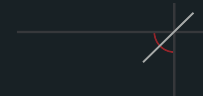

ENQUIRIES

01843 44 66 79 |
info@rhinoaluminium.co.uk |
www.rhinoaluminium.co.uk |



RHINO
ALUMINIUM